

CM-1B

CARBON MONOXIDE METER AND ALARM

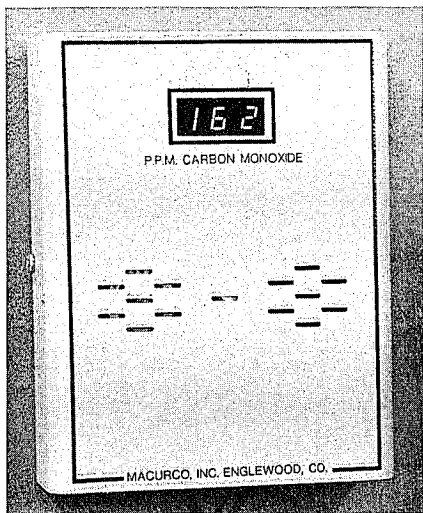

DESCRIPTION/OPERATION:

The CM-1B is a Carbon Monoxide Meter, Alarm and Controller. It is an all electronic system using a microprocessor to measure the quantity of Carbon Monoxide (CO) and calculate the danger level, which is a combination of level of CO and time of exposure.

A three digit lighted display on the CM-1B shows the current level of CO between 0 and 250 parts per million (PPM). The CM-1B continuously monitors the air, and updates the display every 2½ minutes.

The microprocessor analyzes this data and compares it to the 10% Hemoglobin concentration, which is stored in the computer memory. If the danger level is exceeded, the alarm sounds and the alarm relay closes. The fan relay actuates if the average level of CO exceeds 35 PPM for 5 minutes.

FEATURES:

- DIGITAL DISPLAY: Shows the current level of CO: 0-250 PPM
- LOW VOLTAGE OPERATION: Can be powered from most alarm control panels. 120 VAC U.L. LISTED POWER SUPPLY AVAILABLE.
- THE CM-1 CAN BE FIELD CALIBRATED.
- TEST SWITCH: The test switch provides a mode for the system to test itself.
- RELAYS: Close at 35 PPM after 5 minutes and at alarm level.

SPECIFICATIONS:

- POWER: 3 Watts
- VOLTAGE: 10 to 26 VAC or VDC
- SIZE: 5 X 6 X 1½ inches
- SHIPPING WEIGHT: 2 lbs.
- COLOR: Beige
- ALARM SOUND LEVEL: 85db at 10 feet
- ALARM RELAY RATING: 0.5 Amp, 200V, 10VA
- FAN RELAY RATING: 5 Amp, 240V
- ALARM SETTING: Equivalent to 10% CO in Hemoglobin.
- ACCURACY: ± 10% at 50 PPM CO
- SENSOR MAINTENANCE: Not required

NOTE:

The CM-1B Alarm actuation curve is a time weighted exposure that approximates the dosage to produce 10% of Carbon Monoxide in the blood hemoglobin. This CM-1B curve meets both the OSHA STEL (Short Term Exposure Limit) of 200 PPM for 15 minutes, and the OSHA TWA (Time Weighted Average) of 35 PPM over 8 hours.

OPTIONS:

- CMP: U.L. 120 VAC outlet mounted power supply w/ 10-foot cord.
- CM-1B-FCK: Field Calibration Kit.

MOUNT THE CM-1B IN A CENTRAL LOCATION ON A WALL OR COLUMN

CARBON MONOXIDE DANGER LEVELS

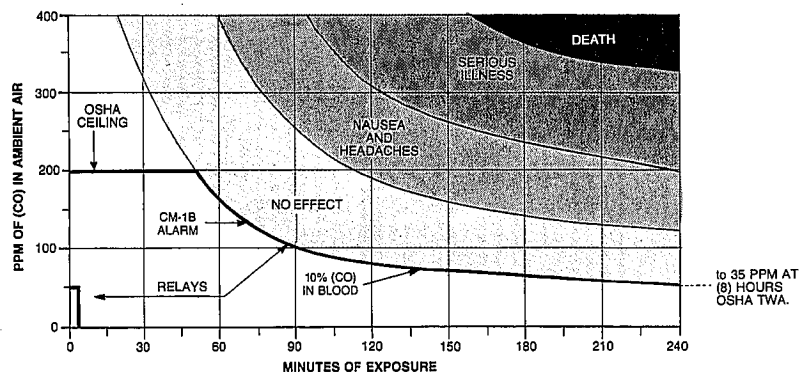

MANUFACTURED BY

MACURCO inc.

3946 S. Mariposa Street
Englewood, Colorado 80110
303-781-4062 Fax: 303-761-6640
www.macurco.com

DISTRIBUTED BY

CM-1B APPLICATIONS

RESIDENTIAL INSTALLATION:

For detection of Carbon Monoxide from faulty furnaces or backed up fireplaces.

Mount the CM-1B in a hall near the sleeping area, where the alarm buzzer can be heard by the people in the bedrooms.

Mount the CM-1B on the wall (5) feet above the floor.

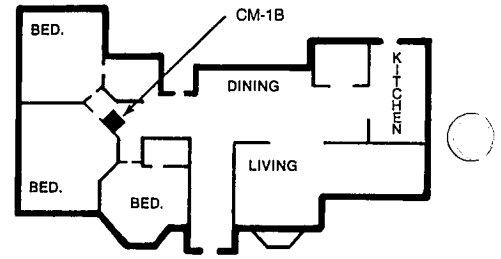

RESIDENTIAL INSTALLATION:

For detection of Carbon Monoxide from cars in adjoining garages.

Mount the CM-1B on a wall, (5) feet above the floor in a bedroom above the garage, and in all rooms adjacent to the garage. Do not mount in the garage, unless it is to exhaust the garage as shown below.

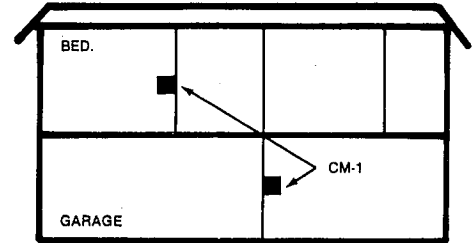

PARKING GARAGE INSTALLATION:

To meet OSHA and Building Codes for ventilation control and local alarm, for small garages (up to 5000 square feet). For larger garages, use the Macurco SS 102/103 Systems.

This system turns on exhaust fans at (35) PPM of CO. Fans will run at least 2.5 minutes, and will automatically turn off when CO level drops. The CM-1B buzzer sounds if CO level exceeds alarm point: see chart on other side.

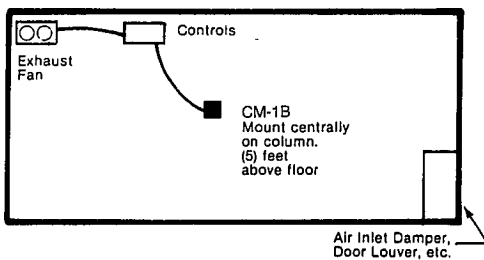

CONTROL CONNECTIONS:

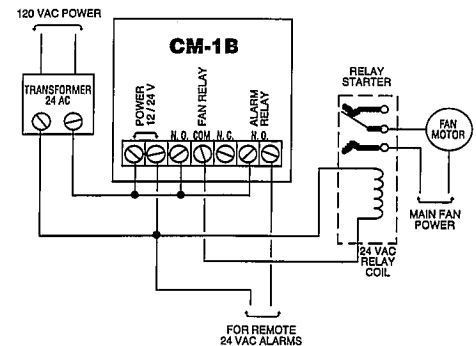

AUTHORIZED DISTRIBUTOR:

GasDetectorsUSA.com

Houston, Texas USA

sales@GasDetectorsUSA.com

832-615-3588

TYPICAL ALARM CONTROL PANEL CONNECTION:

The CM-1B can be used with Fire or Burglar alarm panels that operate on 12 VDC or 24 VDC. This alarm panel provides the power to the CM-1B, and uses the alarm relay closure to actuate the panels alarm circuits.

NOTE: Macurco, Inc. supplies this CM-1B Detector only.

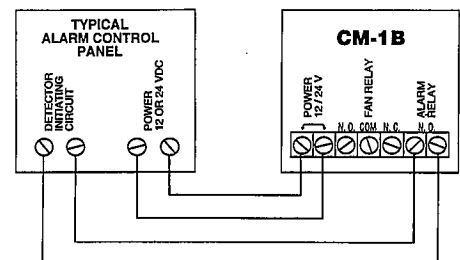

SCHOOL BUSES, LIGHT AIRPLANES, MOTOR HOMES, BOATS

The CM-1B works on 12 VDC or 24 VDC power. It can be mounted in the vehicle, boats, or plane to warn of the danger of excessive Carbon Monoxide levels.

INDUSTRIAL/INSTITUTIONAL:

Monitor the air for a safe environment. The CM-1B will alarm within OSHA limits for a safe work place.